

Dell Inspiron 3521/5521

Owner's Manual

Computer model: Inspiron 3521/5521

Regulatory model: P28F

Regulatory type: P28F001



Notes, Cautions, and Warnings



NOTE: A NOTE indicates important information that helps you make better use of your computer.



CAUTION: A CAUTION indicates potential damage to hardware or loss of data if instructions are not followed.



WARNING: A WARNING indicates a potential for property damage, personal injury, or death.

© 2012 Dell Inc.

Trademarks used in this text: Dell™, the DELL logo, and Inspiron™ are trademarks of Dell Inc.; Microsoft®, Windows®, and the Windows start button logo are either trademarks or registered trademarks of Microsoft Corporation in the United States and/or other countries; Bluetooth® is a registered trademark owned by Bluetooth SIG, Inc. and is used by Dell under license.

Contents

| | | |
|-----------|---|-----------|
| 1 | Before You Begin | 7 |
| | Turn Off Your Computer and Connected Devices . . . | 7 |
| | Safety Instructions | 7 |
| | Recommended Tools | 8 |
| 2 | After Working Inside Your Computer | 9 |
| 3 | Removing the Battery | 11 |
| | Procedure | 11 |
| 4 | Replacing the Battery | 13 |
| | Procedure | 13 |
| | Postrequisites | 13 |
| 5 | Removing the Memory Module(s) | 15 |
| | Prerequisites | 15 |
| | Procedure | 15 |
| 6 | Replacing the Memory Module(s) | 17 |
| | Procedure | 17 |
| | Postrequisites | 17 |
| 7 | Removing the Optical-Drive Assembly | 19 |
| | Prerequisites | 19 |
| | Procedure | 19 |
| 8 | Replacing the Optical-Drive Assembly | 21 |
| | Procedure | 21 |
| | Postrequisites | 21 |
| 9 | Removing the Hard-Drive Assembly | 23 |
| | Prerequisites | 23 |
| | Procedure | 23 |
| 10 | Replacing the Hard-Drive Assembly | 25 |
| | Procedure | 25 |
| | Postrequisites | 25 |

| | |
|--|-----------|
| 11 Removing the Keyboard | 27 |
| Prerequisites | 27 |
| Procedure | 27 |
| 12 Replacing the Keyboard | 29 |
| Procedure | 29 |
| Postrequisites | 29 |
| 13 Removing the Palm-Rest | 31 |
| Prerequisites | 31 |
| Procedure | 31 |
| 14 Replacing the Palm-Rest | 35 |
| Procedure | 35 |
| Postrequisites | 35 |
| 15 Removing the Wireless Mini-Card | 37 |
| Prerequisites | 37 |
| Procedure | 38 |
| 16 Replacing the Wireless Mini-Card | 39 |
| Procedure | 39 |
| Postrequisites | 40 |
| 17 Removing the I/O Board | 41 |
| Prerequisites | 41 |
| Procedure | 42 |
| 18 Replacing the I/O Board | 43 |
| Procedure | 43 |
| Postrequisites | 43 |
| 19 Removing the System Board | 45 |
| Prerequisites | 45 |
| Procedure | 46 |
| 20 Replacing the System Board | 49 |
| Procedure | 49 |
| Postrequisites | 49 |
| Entering the Service Tag in system setup | 49 |

| | |
|---|-----------|
| 21 Removing the Coin-Cell Battery | 51 |
| Prerequisites | 51 |
| Procedure | 52 |
| 22 Replacing the Coin-Cell Battery | 53 |
| Procedure | 53 |
| Postrequisites | 53 |
| 23 Removing the Heat-Sink | 55 |
| Prerequisites | 55 |
| Procedure | 56 |
| 24 Replacing the Heat-Sink | 57 |
| Procedure | 57 |
| Postrequisites | 57 |
| 25 Removing the Fan | 59 |
| Prerequisites | 59 |
| Procedure | 60 |
| 26 Replacing the Fan | 61 |
| Procedure | 61 |
| Postrequisites | 61 |
| 27 Removing the Speakers | 63 |
| Prerequisites | 63 |
| Procedure | 64 |
| 28 Replacing the Speakers | 67 |
| Procedure | 67 |
| Postrequisites | 67 |
| 29 Removing the Display Assembly | 69 |
| Prerequisites | 69 |
| Procedure | 70 |
| 30 Replacing the Display Assembly | 73 |
| Procedure | 73 |
| Postrequisites | 73 |

| | |
|--|-----------|
| 31 Removing the Display Bezel | 75 |
| Prerequisites | 75 |
| Procedure | 76 |
| 32 Replacing the Display Bezel | 77 |
| Procedure | 77 |
| Postrequisites | 77 |
| 33 Removing the Display Hinges | 79 |
| Prerequisites | 79 |
| Procedure | 80 |
| 34 Replacing the Display Hinges | 81 |
| Procedure | 81 |
| Postrequisites | 81 |
| 35 Removing the Display Panel | 83 |
| Prerequisites | 83 |
| Procedure | 84 |
| 36 Replacing the Display Panel | 87 |
| Procedure | 87 |
| Postrequisites | 87 |
| 37 Removing the Camera Module | 89 |
| Prerequisites | 89 |
| Procedure | 90 |
| 38 Replacing the Camera Module | 91 |
| Procedure | 91 |
| Postrequisites | 91 |
| 39 Flashing the BIOS | 93 |

Before You Begin

Turn Off Your Computer and Connected Devices

 **CAUTION:** To avoid losing data, save and close all open files and exit all open programs before you turn off your computer.

- 1 Save and close all open files and exit all open programs.
- 2 Follow the instructions to shut down your computer based on the operating system installed on your computer.
 - *Windows 8:*
Move your mouse pointer to the upper-right or lower-right corner of the screen to open the Charms sidebar, and then click **Settings**→ **Power**→ **Shutdown**.
 - *Windows 7:*
Click **Start**  and click **Shut down**.

Microsoft Windows shuts down and then the computer turns off.

 **NOTE:** If you are using a different operating system, see the documentation of your operating system for shut-down instructions.

- 3 Disconnect your computer and all attached devices from their electrical outlets.
- 4 Disconnect all telephone cables, network cables, and attached devices from your computer.
- 5 Press and hold the power button for 5 seconds, after the computer is unplugged, to ground the system board.

Safety Instructions

Use the following safety guidelines to protect your computer from potential damage and ensure your personal safety.

 **WARNING:** Before working inside your computer, read the safety information that shipped with your computer. For additional safety best practices information, see the Regulatory Compliance Homepage at dell.com/regulatory_compliance.

 **WARNING:** Disconnect all power sources before opening the computer cover or panels. After you finish working inside the computer, replace all covers, panels, and screws before connecting to the power source.

 **CAUTION:** To avoid damaging the computer, ensure that the work surface is flat and clean.

 **CAUTION:** To avoid damaging the components and cards, handle them by their edges and avoid touching pins and contacts.

- △ **CAUTION:** Only a certified service technician is authorized to remove the computer cover and access any of the components inside the computer. See the safety instructions for complete information about safety precautions, working inside your computer, and protecting against electrostatic discharge.
- △ **CAUTION:** Before touching anything inside your computer, ground yourself by touching an unpainted metal surface, such as the metal at the back of the computer. While you work, periodically touch an unpainted metal surface to dissipate static electricity, which could harm internal components.
- △ **CAUTION:** When you disconnect a cable, pull on its connector or on its pull-tab, not on the cable itself. Some cables have connectors with locking tabs or thumb-screws that you must disengage before disconnecting the cable. When disconnecting cables, keep them evenly aligned to avoid bending any connector pins. When connecting cables, ensure that the connectors and ports are correctly oriented and aligned.
- △ **CAUTION:** To disconnect a network cable, first unplug the cable from your computer and then unplug the cable from the network device.
- △ **CAUTION:** Press and eject any installed card from the media-card reader.

Recommended Tools

The procedures in this document may require the following tools:

- Phillips screwdriver
- Plastic scribe

After Working Inside Your Computer

After you complete the replacement procedures, ensure the following:

- Replace all screws and ensure that no stray screws remain inside your computer.
- Connect any external devices, cables, cards, and any other part(s) you removed before working on your computer.
- Connect your computer and all attached devices to their electrical outlets.



CAUTION: Before turning on your computer, replace all screws and ensure that no stray screws remain inside the computer. Failure to do so may damage your computer.

Removing the Battery

⚠ WARNING: Before working inside your computer, read the safety information that shipped with your computer and follow the steps in "Before You Begin" on page 7. After working inside your computer, follow the instructions in "After Working Inside Your Computer" on page 9. For additional safety best practices information, see the Regulatory Compliance Homepage at dell.com/regulatory_compliance.

Procedure

- 1 Close the display and turn the computer over.
- 2 Slide the battery latches on each end of the battery bay to the unlock position. You will hear a click when the battery is unlocked.
- 3 Lift and remove the battery off the computer base to disconnect it from the computer.

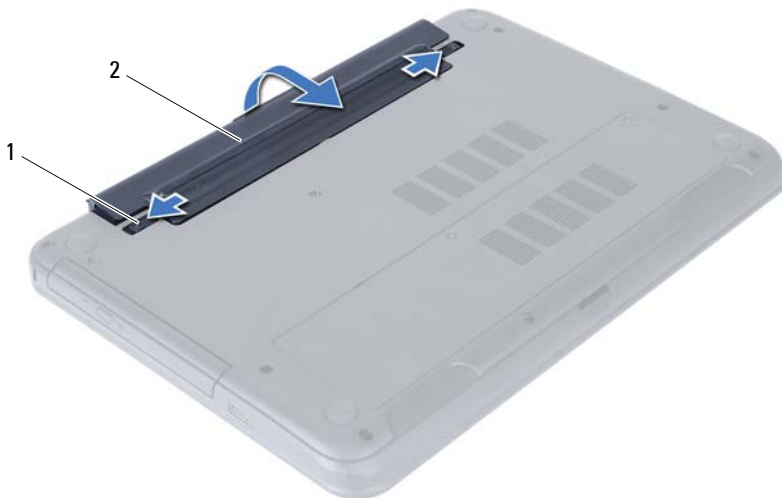

1 battery latches (2)

2 battery

Replacing the Battery



WARNING: Before working inside your computer, read the safety information that shipped with your computer and follow the steps in "Before You Begin" on page 7. After working inside your computer, follow the instructions in "After Working Inside Your Computer" on page 9. For additional safety best practices information, see the Regulatory Compliance Homepage at dell.com/regulatory_compliance.

Procedure

Align the tabs on the battery with the slots on the battery bay and snap the battery into place.

Postrequisites

- 1 Follow the instructions in "After Working Inside Your Computer" on page 9.

Removing the Memory Module(s)

⚠ WARNING: Before working inside your computer, read the safety information that shipped with your computer and follow the steps in "Before You Begin" on page 7. After working inside your computer, follow the instructions in "After Working Inside Your Computer" on page 9. For additional safety best practices information, see the Regulatory Compliance Homepage at dell.com/regulatory_compliance.

Prerequisites

- 1 Remove the battery. See "Removing the Battery" on page 11.

Procedure

- 1 Loosen the captive screw that secures the memory-module cover to the computer base.
- 2 Using your fingertips, lift the memory-module cover out of the slots on the computer base.



1 captive screw

2 memory-module cover

- 3 Use your fingertips to carefully spread apart the securing clips on each end of the memory-module connector until the memory module pops up.
- 4 Remove the memory module from the memory-module connector.

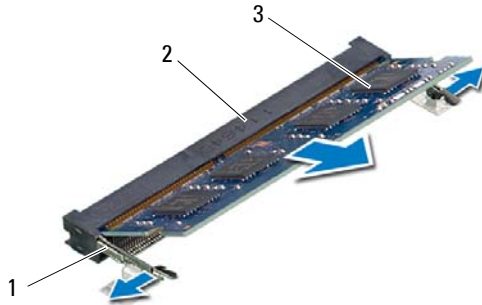

1 securing clips (2)

2 memory-module connector

3 memory module

Replacing the Memory Module(s)



WARNING: Before working inside your computer, read the safety information that shipped with your computer and follow the steps in "Before You Begin" on page 7. After working inside your computer, follow the instructions in "After Working Inside Your Computer" on page 9. For additional safety best practices information, see the Regulatory Compliance Homepage at dell.com/regulatory_compliance.

Procedure

- 1 Align the notch on the memory module with the tab on the memory-module connector.
- 2 Slide the memory module firmly into the connector at a 45-degree angle and press the memory module down until it clicks into place.
 **NOTE:** If you do not hear the click, remove the memory module and reinstall it.
- 3 Slide the tabs on the memory-module cover into the slots on the computer base and snap the memory-module cover into place.
- 4 Tighten the captive screw that secures the memory-module cover to the computer base.

Postrequisites

- 1 Replace the battery. See "Replacing the Battery" on page 13.
- 2 Follow the instructions in "After Working Inside Your Computer" on page 9.

Removing the Optical-Drive Assembly

⚠ WARNING: Before working inside your computer, read the safety information that shipped with your computer and follow the steps in "Before You Begin" on page 7. After working inside your computer, follow the instructions in "After Working Inside Your Computer" on page 9. For additional safety best practices information, see the Regulatory Compliance Homepage at dell.com/regulatory_compliance.

Prerequisites

- 1 Remove the battery. See "Removing the Battery" on page 11.

Procedure

- 1 Remove the screw that secures the optical-drive assembly to the computer base.
- 2 Using your fingertips, slide the optical-drive assembly out of the optical-drive bay.

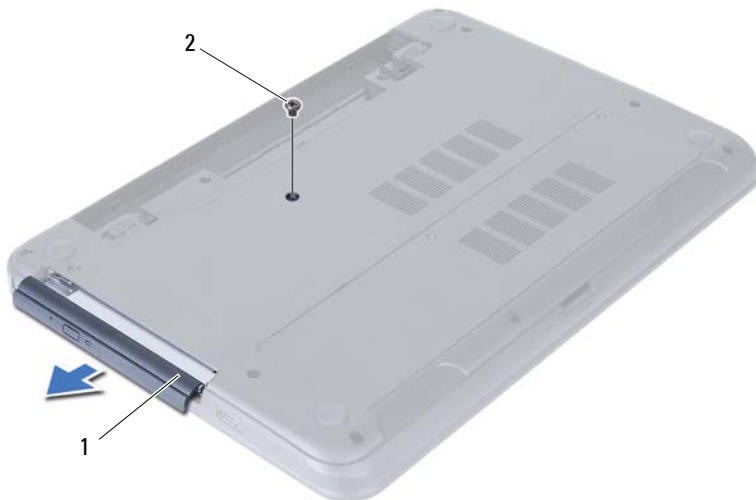

1 optical-drive assembly

2 screw

- 3 Remove the screws that secure the optical-drive bracket to the optical-drive assembly.
- 4 Remove the optical-drive bracket from the optical-drive assembly.
- 5 Carefully pry the optical-drive bezel and remove it from the optical-drive assembly.



1 optical-drive bezel

2 optical drive

3 screws (2)

4 optical-drive bracket

Replacing the Optical-Drive Assembly



WARNING: Before working inside your computer, read the safety information that shipped with your computer and follow the steps in "Before You Begin" on page 7. After working inside your computer, follow the instructions in "After Working Inside Your Computer" on page 9. For additional safety best practices information, see the Regulatory Compliance Homepage at dell.com/regulatory_compliance.

Procedure

- 1 Align the tabs on the optical-drive bezel with the slots on the optical drive and snap optical-drive bezel into place.
- 2 Align the screw holes on the optical-drive bracket with the screw holes on the optical-drive assembly.
- 3 Replace the screws that secure the optical-drive bracket to the optical-drive assembly.
- 4 Slide the optical-drive assembly into position and ensure that the screw hole on the optical-drive bracket aligns with the screw hole on computer base.

Postrequisites

- 1 Replace the battery. See "Replacing the Battery" on page 13.
- 2 Follow the instructions in "After Working Inside Your Computer" on page 9.

Removing the Hard-Drive Assembly

⚠ WARNING: Before working inside your computer, read the safety information that shipped with your computer and follow the steps in "Before You Begin" on page 7. After working inside your computer, follow the instructions in "After Working Inside Your Computer" on page 9. For additional safety best practices information, see the Regulatory Compliance Homepage at dell.com/regulatory_compliance.

⚠ CAUTION: To avoid data loss, do not remove the hard drive while the computer is in Sleep or On state.

⚠ CAUTION: Hard drives are extremely fragile. Exercise care when handling the hard drive.

Prerequisites

- 1 Remove the battery. See "Removing the Battery" on page 11.
- 2 Follow the instructions from step 1 to step 2 in "Removing the Memory Module(s)" on page 15.

Procedure

- 1 Remove the screws that secure the hard-drive assembly to the computer base.
- 2 Slide the hard-drive assembly forward to disconnect the hard-drive assembly from the system board.



1 screws (2)

2 hard-drive assembly

- 3 Using the pull-tab, lift the hard-drive assembly out of the computer base.



1 hard-drive assembly

2 pull-tab

- 4 Remove the screws that secure the hard-drive bracket to the hard drive.
5 Lift the hard-drive bracket off the hard drive.



1 screws (2)

2 hard-drive bracket

Replacing the Hard-Drive Assembly

 **WARNING:** Before working inside your computer, read the safety information that shipped with your computer and follow the steps in "Before You Begin" on page 7. After working inside your computer, follow the instructions in "After Working Inside Your Computer" on page 9. For additional safety best practices information, see the Regulatory Compliance Homepage at dell.com/regulatory_compliance.

 **CAUTION:** Hard drives are extremely fragile. Exercise care when handling the hard drive.

Procedure

- 1 Align the screw holes on the hard-drive bracket with the screw holes on the hard drive.
- 2 Replace the screws that secure the hard-drive bracket to the hard drive.
- 3 Slide and place the hard-drive assembly in the hard-drive bay.
- 4 Slide the hard-drive assembly backward to connect the hard-drive assembly to the system board.
- 5 Replace the screws that secure the hard-drive assembly to the computer base.

Postrequisites

- 1 Follow the instructions from step 3 to step 4 in "Replacing the Memory Module(s)" on page 17.
- 2 Replace the battery. See "Replacing the Battery" on page 13.
- 3 Follow the instructions in "After Working Inside Your Computer" on page 9.

Removing the Keyboard

⚠ WARNING: Before working inside your computer, read the safety information that shipped with your computer and follow the steps in "Before You Begin" on page 7. After working inside your computer, follow the instructions in "After Working Inside Your Computer" on page 9. For additional safety best practices information, see the Regulatory Compliance Homepage at dell.com/regulatory_compliance.

Prerequisites

- 1 Remove the battery. See "Removing the Battery" on page 11.

Procedure

- 1 Turn the computer over and open the display as far as possible.
- 2 Using a plastic scribe, release the keyboard from the tabs on the palm-rest assembly.

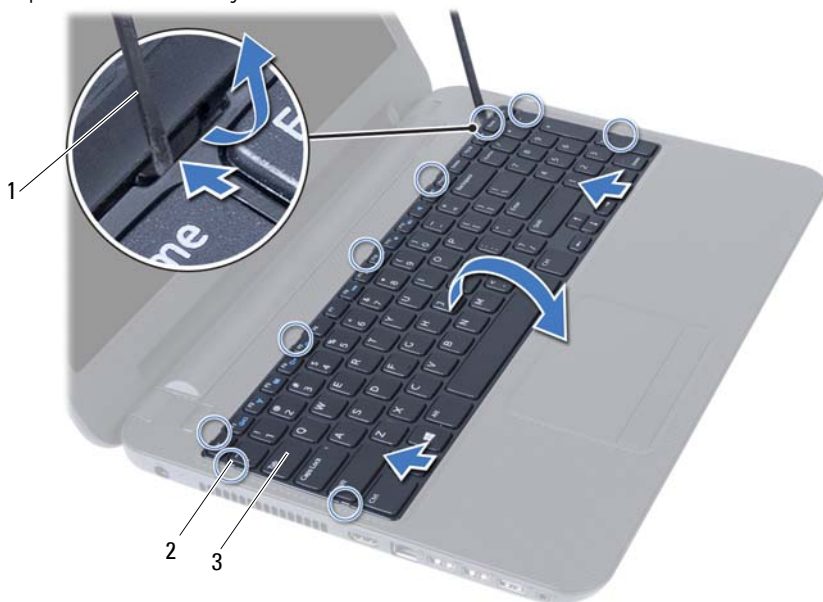

1 plastic scribe

2 tabs (9)

3 keyboard

- 3 Lift and slide the keyboard towards the display to release the keyboard from the palm-rest assembly.
- 4 Turn the keyboard over and place it on the palm-rest assembly.
- 5 Lift the connector latch and disconnect the keyboard from the connector on the system board.
- 6 Lift the keyboard off the palm-rest assembly.

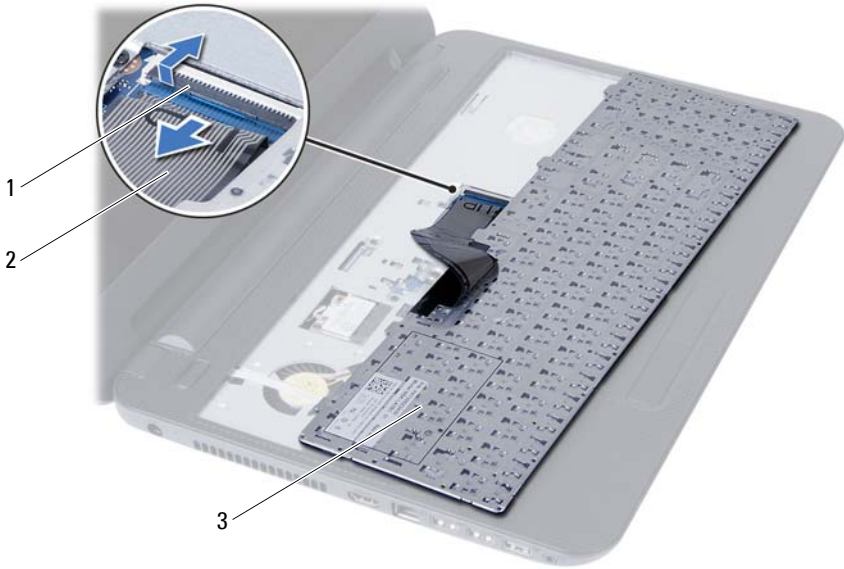

1 connector latch

2 keyboard cable

3 keyboard

Replacing the Keyboard



WARNING: Before working inside your computer, read the safety information that shipped with your computer and follow the steps in "Before You Begin" on page 7. After working inside your computer, follow the instructions in "After Working Inside Your Computer" on page 9. For additional safety best practices information, see the Regulatory Compliance Homepage at dell.com/regulatory_compliance.

Procedure

- 1 Slide the keyboard cable into the connector on the system board and press down on the connector latch to secure it.
- 2 Slide the tabs at the bottom of the keyboard into the slots on the palm-rest assembly and place the keyboard on the palm-rest assembly.
- 3 Gently press around the edges of the keyboard to secure the keyboard under the tabs on the palm-rest assembly.

Postrequisites

- 1 Replace the battery. See "Replacing the Battery" on page 13.
- 2 Follow the instructions in "After Working Inside Your Computer" on page 9.

Removing the Palm-Rest

⚠ WARNING: Before working inside your computer, read the safety information that shipped with your computer and follow the steps in "Before You Begin" on page 7. After working inside your computer, follow the instructions in "After Working Inside Your Computer" on page 9. For additional safety best practices information, see the Regulatory Compliance Homepage at dell.com/regulatory_compliance.

Prerequisites

- 1 Remove the battery. See "Removing the Battery" on page 11.
- 2 Follow the instructions from step 1 to step 2 in "Removing the Memory Module(s)" on page 15.
- 3 Remove the optical-drive assembly. See "Removing the Optical-Drive Assembly" on page 19.
- 4 Remove the keyboard. See "Removing the Keyboard" on page 27.

Procedure

- 1 Close the display and turn the computer over.
- 2 Remove the screws that secure the palm-rest to the computer base.



1 screws (12)

- 3 Turn the computer over and open the display as far as possible.
- 4 Lift the connector latches and pull the pull-tab to disconnect the touchpad cable and the power-button cable from the system board.



-
- | | |
|---|-----------------------|
| 1 | touchpad cable |
| 3 | connector latches (2) |
-

-
- | | |
|---|--------------------|
| 2 | power-button cable |
|---|--------------------|
-

- 5 Remove the screws that secure the palm-rest to the system board.
- 6 Using a plastic scribe gently lift and release the tabs on palm-rest from the slots on the computer base.

△ CAUTION: Carefully separate the palm-rest assembly from the display assembly to avoid damage to the display assembly.

- 7 Lift the palm-rest off the computer base.

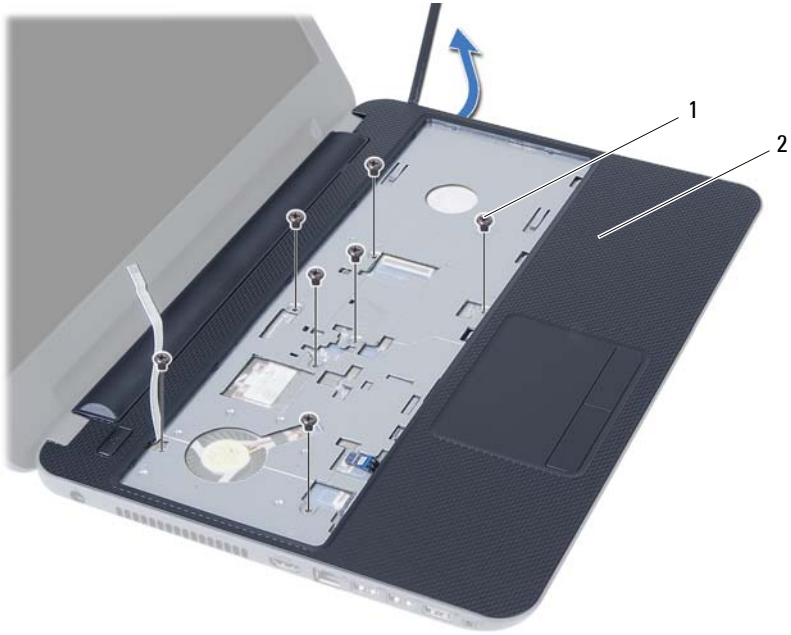

1 screws (7)

2 palm-rest

Replacing the Palm-Rest



WARNING: Before working inside your computer, read the safety information that shipped with your computer and follow the steps in "Before You Begin" on page 7. After working inside your computer, follow the instructions in "After Working Inside Your Computer" on page 9. For additional safety best practices information, see the Regulatory Compliance Homepage at dell.com/regulatory_compliance.

Procedure

- 1 Align the palm-rest over the computer base.
- 2 Press down on the palm-rest to snap it into place.
- 3 Slide the touchpad cable and the power-button cable into the connectors on the system board and press down on the connector latches to secure the cables.
- 4 Replace the screws that secure the palm-rest to the system board.
- 5 Close the display and turn the computer over.
- 6 Replace the screws that secure the palm-rest to the computer base.

Postrequisites

- 1 Replace the keyboard. See "Replacing the Keyboard" on page 29.
- 2 Replace the optical-drive assembly. See "Replacing the Optical-Drive Assembly" on page 21.
- 3 Follow the instructions from step 3 and step 4 in "Replacing the Memory Module(s)" on page 17.
- 4 Replace the battery. See "Replacing the Battery" on page 13.
- 5 Follow the instructions in "After Working Inside Your Computer" on page 9.

Removing the Wireless Mini-Card



WARNING: Before working inside your computer, read the safety information that shipped with your computer and follow the steps in "Before You Begin" on page 7. After working inside your computer, follow the instructions in "After Working Inside Your Computer" on page 9. For additional safety best practices information, see the Regulatory Compliance Homepage at dell.com/regulatory_compliance.



NOTE: Dell does not guarantee compatibility or provide support for wireless mini-cards from sources other than Dell.

If you ordered a wireless mini-card with your computer, the card is already installed. Your computer has a half wireless mini-card slot which supports a Wireless Local Area Network (WLAN) + Bluetooth combo card.

Prerequisites

- 1 Remove the battery. See "Removing the Battery" on page 11.
- 2 Follow the instructions from step 1 to step 2 in "Removing the Memory Module(s)" on page 15.
- 3 Remove the optical-drive assembly. See "Removing the Optical-Drive Assembly" on page 19.
- 4 Remove the keyboard. See "Removing the Keyboard" on page 27.
- 5 Remove the palm-rest. See "Removing the Palm-Rest" on page 31.

Procedure

- 1 Disconnect the antenna cables from the connectors on the wireless mini-card.
- 2 Remove the screw that secures the wireless mini-card to the system-board connector.

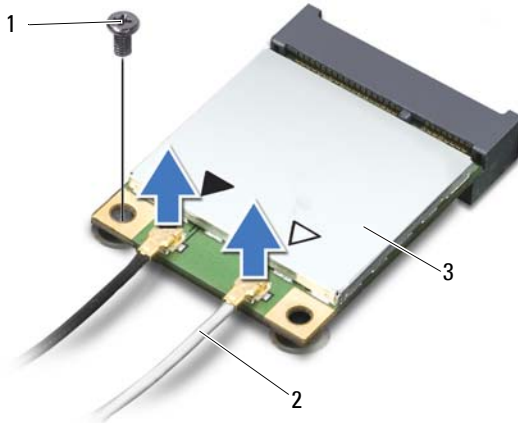

| | | | |
|---|--------------------|---|--------------------|
| 1 | screw | 2 | antenna cables (2) |
| 3 | wireless mini-card | | |

- 3 Slide and remove the wireless mini-card out of the system-board connector.

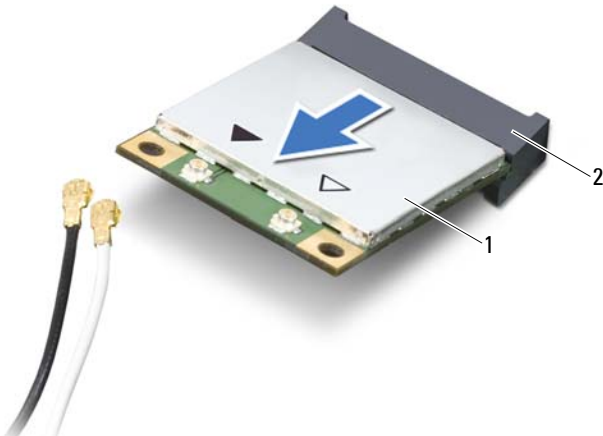

| | | | |
|---|--------------------|---|------------------------|
| 1 | wireless mini-card | 2 | system-board connector |
|---|--------------------|---|------------------------|

Replacing the Wireless Mini-Card

 **WARNING:** Before working inside your computer, read the safety information that shipped with your computer and follow the steps in "Before You Begin" on page 7. After working inside your computer, follow the instructions in "After Working Inside Your Computer" on page 9. For additional safety best practices information, see the Regulatory Compliance Homepage at dell.com/regulatory_compliance.

Procedure

 **CAUTION:** To avoid damage to the wireless mini-card, ensure that no cables are placed under the wireless mini-card.

- 1 Align the notch on the wireless mini-card with the tab on the system-board connector.
- 2 Insert the wireless mini-card connector at a 45-degree angle into the connector on the system board.
- 3 Press the other end of the wireless mini-card down into the slot on the system board and replace the screw that secures the wireless mini-card to the system board.
- 4 Connect the antenna cables to the wireless mini-card.

The following table provides the antenna cable color schemes for the wireless mini-card supported by your computer.

| Connectors on the wireless mini-card | Antenna cable color schemes |
|---|-----------------------------|
| WLAN + Bluetooth (2 cables) | |
| Main WLAN + Bluetooth (white triangle) | white |
| Auxiliary WLAN + Bluetooth (black triangle) | black |

Postrequisites

- 1 Replace the palm-rest. See "Replacing the Palm-Rest" on page 35.
- 2 Replace the keyboard. See "Replacing the Keyboard" on page 29.
- 3 Replace the optical-drive assembly. See "Replacing the Optical-Drive Assembly" on page 21.
- 4 Follow the instructions from step 3 and step 4 in "Replacing the Memory Module(s)" on page 17.
- 5 Replace the battery. See "Replacing the Battery" on page 13.
- 6 Follow the instructions in "After Working Inside Your Computer" on page 9.

Removing the I/O Board



WARNING: Before working inside your computer, read the safety information that shipped with your computer and follow the steps in "Before You Begin" on page 7. After working inside your computer, follow the instructions in "After Working Inside Your Computer" on page 9. For additional safety best practices information, see the Regulatory Compliance Homepage at dell.com/regulatory_compliance.

Prerequisites

- 1 Remove the battery. See "Removing the Battery" on page 11.
- 2 Follow the instructions from step 1 to step 2 in "Removing the Memory Module(s)" on page 15.
- 3 Remove the optical-drive assembly. See "Removing the Optical-Drive Assembly" on page 19.
- 4 Remove the keyboard. See "Removing the Keyboard" on page 27.
- 5 Remove the palm-rest. See "Removing the Palm-Rest" on page 31.

Procedure

- 1 Remove the screw that secures the I/O board to the computer base.
- 2 Use the pull-tab to disconnect the I/O board cable from the connector on the system board.
- 3 Gently lift and remove the I/O board off the computer base.

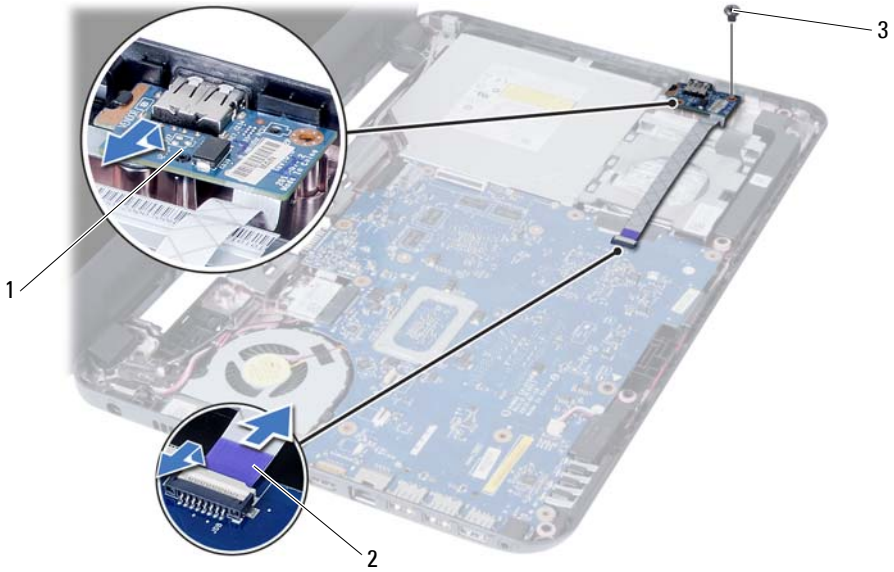

1 I/O board

2 I/O board cable

3 screw

Replacing the I/O Board



WARNING: Before working inside your computer, read the safety information that shipped with your computer and follow the steps in "Before You Begin" on page 7. After working inside your computer, follow the instructions in "After Working Inside Your Computer" on page 9. For additional safety best practices information, see the Regulatory Compliance Homepage at dell.com/regulatory_compliance.

Procedure

- 1 Gently slide the I/O board below the tab that secures it and snap the I/O board into place.
- 2 Replace the screw that secures the I/O board to the computer base.
- 3 Connect the I/O board cable to the connector on the I/O board.

Postrequisites

- 1 Replace the palm-rest. See "Replacing the Palm-Rest" on page 35.
- 2 Replace the keyboard. See "Replacing the Keyboard" on page 29.
- 3 Replace the optical-drive assembly. See "Replacing the Optical-Drive Assembly" on page 21.
- 4 Follow the instructions from step 3 and step 4 in "Replacing the Memory Module(s)" on page 17.
- 5 Replace the battery. See "Replacing the Battery" on page 13.
- 6 Follow the instructions in "After Working Inside Your Computer" on page 9.

Removing the System Board



WARNING: Before working inside your computer, read the safety information that shipped with your computer and follow the steps in "Before You Begin" on page 7. After working inside your computer, follow the instructions in "After Working Inside Your Computer" on page 9. For additional safety best practices information, see the Regulatory Compliance Homepage at dell.com/regulatory_compliance.



NOTE: Your computer's Service Tag is stored in the system board. You must enter the Service Tag in system setup after you replace the system board. For more information, see "Entering the Service Tag in system setup" on page 49.



NOTE: Before disconnecting the cables from the system board, note the location of the connectors so that you can reconnect them correctly after you replace the system board.

Prerequisites

- 1 Remove the battery. See "Removing the Battery" on page 11.
- 2 Follow the instructions from step 1 to step 2 in "Removing the Memory Module(s)" on page 15.
- 3 Remove the hard-drive assembly. See "Removing the Hard-Drive Assembly" on page 23.
- 4 Remove the optical-drive assembly. See "Removing the Optical-Drive Assembly" on page 19.
- 5 Remove the keyboard. See "Removing the Keyboard" on page 27.
- 6 Remove the palm-rest. See "Removing the Palm-Rest" on page 31.
- 7 Remove the wireless Mini-Card. See "Removing the Wireless Mini-Card" on page 37.

Procedure

- 1 Peel the tape that secures the display cable to the system board.
- 2 Disconnect the display cable from the connector on the system board.
- 3 Disconnect the power adapter-port cable, speaker cable, and the I/O board cable from the system board.

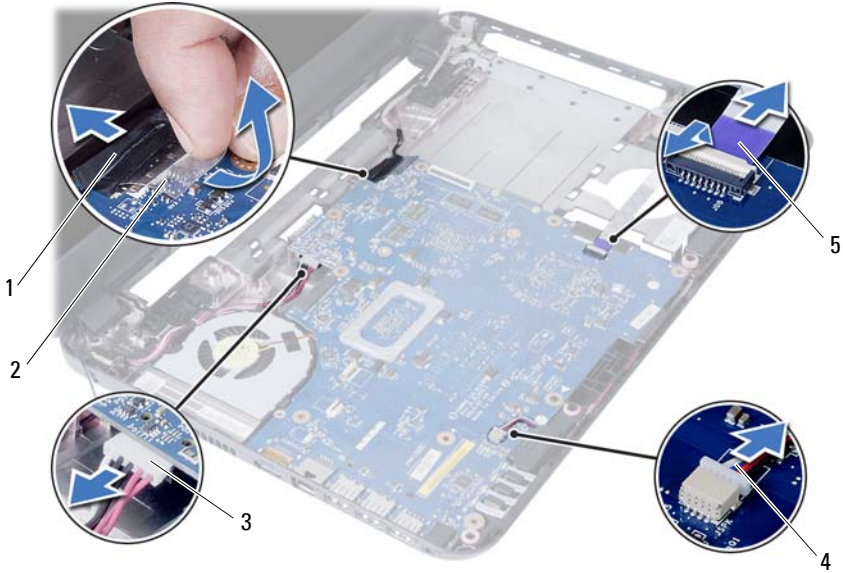

| | | | |
|---|--------------------------|---|---------------|
| 1 | display cable | 2 | tape |
| 3 | power-adapter-port cable | 4 | speaker cable |
| 5 | I/O board cable | | |

- 4 Remove the screw that secures the system board to the computer base.
- 5 Lift the system board off the computer base.



1 system board

screw

Replacing the System Board



WARNING: Before working inside your computer, read the safety information that shipped with your computer and follow the steps in "Before You Begin" on page 7. After working inside your computer, follow the instructions in "After Working Inside Your Computer" on page 9. For additional safety best practices information, see the Regulatory Compliance Homepage at dell.com/regulatory_compliance.



NOTE: Your computer's Service Tag is stored in the system board. You must enter the Service Tag in the system setup after you replace the system board.

Procedure

- 1 Align the screw hole on the system board with the screw hole on the computer base.
- 2 Replace the screw that secures the system board to the computer base.
- 3 Connect the power-adaptor-port cable, speaker cable, and the I/O board cable to the connectors on the system board.
- 4 Connect the display cable to the system board.
- 5 Adhere the tape that secures the display cable to the system board.

Postrequisites

- 1 Replace the wireless Mini-Card. See "Replacing the Wireless Mini-Card" on page 39.
- 2 Replace the palm-rest. See "Replacing the Palm-Rest" on page 35.
- 3 Replace the keyboard. See "Replacing the Keyboard" on page 29.
- 4 Replace the optical-drive assembly. See "Replacing the Optical-Drive Assembly" on page 21.
- 5 Replace the hard-drive assembly. See "Replacing the Hard-Drive Assembly" on page 25.
- 6 Follow the instructions from step 3 and step 4 in "Replacing the Memory Module(s)" on page 17.
- 7 Replace the battery. See "Replacing the Battery" on page 13.
- 8 Follow the instructions in "After Working Inside Your Computer" on page 9.

Entering the Service Tag in system setup

- 1 Turn on the computer.
- 2 Press <F2> during POST to enter system setup.
- 3 Navigate to the **Main** tab and enter your computer's Service Tag in the **Service Tag Input** field.

Removing the Coin-Cell Battery

 **WARNING:** Before working inside your computer, read the safety information that shipped with your computer and follow the steps in "Before You Begin" on page 7. After working inside your computer, follow the instructions in "After Working Inside Your Computer" on page 9. For additional safety best practices information, see the Regulatory Compliance Homepage at dell.com/regulatory_compliance.

 **WARNING:** The coin-cell battery may explode if installed incorrectly. Replace the coin-cell battery only with the same or equivalent type. Discard used coin-cell batteries according to the manufacturer's instructions.

 **CAUTION:** Removing the coin-cell battery resets the BIOS settings to default. It is recommended that you note the BIOS settings before removing the coin-cell battery.

Prerequisites

- 1 Remove the battery. See "Removing the Battery" on page 11.
- 2 Follow the instructions from step 1 to step 2 in "Removing the Memory Module(s)" on page 15.
- 3 Remove the hard-drive assembly. See "Removing the Hard-Drive Assembly" on page 23.
- 4 Remove the optical-drive assembly. See "Removing the Optical-Drive Assembly" on page 19.
- 5 Remove the keyboard. See "Removing the Keyboard" on page 27.
- 6 Remove the palm-rest. See "Removing the Palm-Rest" on page 31.
- 7 Remove the system board. See "Removing the System Board" on page 45.

Procedure

- 1 Turn the system board over and place it on a flat surface.
- 2 Using a plastic scribe, gently pry out the coin-cell battery out of the battery socket on the system board.

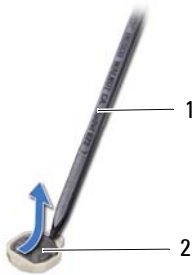

1 plastic scribe

2 coin-cell battery

Replacing the Coin-Cell Battery

 **WARNING:** Before working inside your computer, read the safety information that shipped with your computer and follow the steps in "Before You Begin" on page 7. After working inside your computer, follow the instructions in "After Working Inside Your Computer" on page 9. For additional safety best practices information, see the Regulatory Compliance Homepage at dell.com/regulatory_compliance.

 **WARNING:** The battery may explode if installed incorrectly. Replace the battery only with the same or equivalent type. Discard used batteries according to the manufacturer's instructions.

Procedure

With the positive-side facing up, snap the coin-cell battery into the battery socket on the system board.

Postrequisites

- 1 Replace the system board. See "Replacing the System Board" on page 49.
- 2 Replace the palm-rest. See "Replacing the Palm-Rest" on page 35.
- 3 Replace the keyboard. See "Replacing the Keyboard" on page 29.
- 4 Replace the optical-drive assembly. See "Replacing the Optical-Drive Assembly" on page 21.
- 5 Replace the hard-drive assembly. See "Replacing the Hard-Drive Assembly" on page 25.
- 6 Follow the instructions from step 3 and step 4 in "Replacing the Memory Module(s)" on page 17.
- 7 Replace the battery. See "Replacing the Battery" on page 13.
- 8 Follow the instructions in "After Working Inside Your Computer" on page 9.

Removing the Heat-Sink



WARNING: Before working inside your computer, read the safety information that shipped with your computer and follow the steps in "Before You Begin" on page 7. After working inside your computer, follow the instructions in "After Working Inside Your Computer" on page 9. For additional safety best practices information, see the Regulatory Compliance Homepage at dell.com/regulatory_compliance.

Prerequisites

- 1 Remove the battery. See "Removing the Battery" on page 11.
- 1 Follow the instructions from step 1 to step 2 in "Removing the Memory Module(s)" on page 15.
- 2 Remove the hard-drive assembly. See "Removing the Hard-Drive Assembly" on page 23.
- 3 Remove the optical-drive assembly. See "Removing the Optical-Drive Assembly" on page 19.
- 4 Remove the keyboard. See "Removing the Keyboard" on page 27.
- 5 Remove the palm-rest. See "Removing the Palm-Rest" on page 31.
- 6 Remove the wireless mini-card. See "Removing the Wireless Mini-Card" on page 37.
- 7 Remove the system board. See "Removing the System Board" on page 45.

Procedure

- 1 Turn the system board over and place the system board on a flat surface.
- 2 In sequential order (indicated on the heat-sink), remove the screws that secure the heat-sink to the system board.
- 3 Lift the heat-sink off the system board.

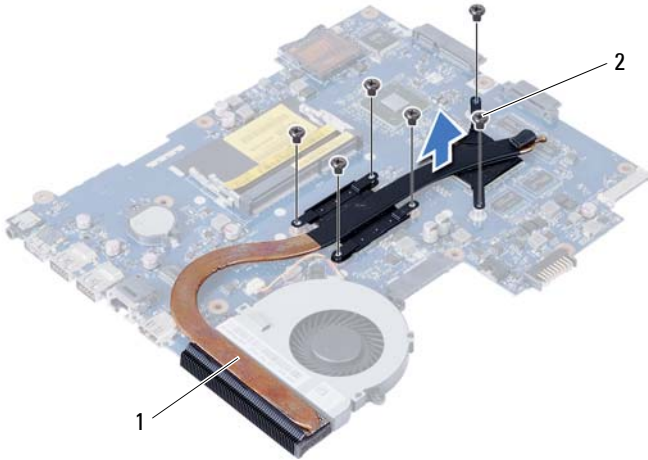

1 screw (6)

2 fan

Replacing the Heat-Sink



WARNING: Before working inside your computer, read the safety information that shipped with your computer and follow the steps in "Before You Begin" on page 7. After working inside your computer, follow the instructions in "After Working Inside Your Computer" on page 9. For additional safety best practices information, see the Regulatory Compliance Homepage at dell.com/regulatory_compliance.

Procedure

- 1 Clean the thermal grease from the bottom of the heat-sink and reapply it.
- 2 Align the screw holes on the heat-sink with the screw holes on the system board.
- 3 In sequential order (indicated on the heat-sink), replace the screws that secure the heat-sink to the system board

Postrequisites

- 1 Replace the system board. See "Replacing the System Board" on page 49.
- 2 Replace the wireless mini-card. See "Replacing the Wireless Mini-Card" on page 39.
- 3 Replace the palm-rest. See "Replacing the Palm-Rest" on page 35.
- 4 Replace the keyboard. See "Replacing the Keyboard" on page 29.
- 5 Replace the optical-drive assembly. See "Replacing the Optical-Drive Assembly" on page 21.
- 6 Replace the hard-drive assembly. See "Replacing the Hard-Drive Assembly" on page 25.
- 7 Follow the instructions from step 3 and step 4 in "Replacing the Memory Module(s)" on page 17.
- 8 Replace the battery. See "Replacing the Battery" on page 13.
- 9 Follow the instructions in "After Working Inside Your Computer" on page 9.

Removing the Fan



WARNING: Before working inside your computer, read the safety information that shipped with your computer and follow the steps in "Before You Begin" on page 7. After working inside your computer, follow the instructions in "After Working Inside Your Computer" on page 9. For additional safety best practices information, see the Regulatory Compliance Homepage at dell.com/regulatory_compliance.

Prerequisites

- 1 Remove the battery. See "Removing the Battery" on page 11.
- 2 Follow the instructions from step 1 to step 2 in "Removing the Memory Module(s)" on page 15.
- 3 Remove the hard-drive assembly. See "Removing the Hard-Drive Assembly" on page 23.
- 4 Remove the optical-drive assembly. See "Removing the Optical-Drive Assembly" on page 19.
- 5 Remove the keyboard. See "Removing the Keyboard" on page 27.
- 6 Remove the palm-rest. See "Removing the Palm-Rest" on page 31.
- 7 Remove the wireless mini-card. See "Removing the Wireless Mini-Card" on page 37.
- 8 Remove the system board. See "Removing the System Board" on page 45.

Procedure

- 1 Turn the system board over and place the system board on a flat surface.
- 2 Disconnect the fan cable from the connector on the system board.
- 3 Remove the screw that secures the fan to the system board.
- 4 Lift the fan off the system board.

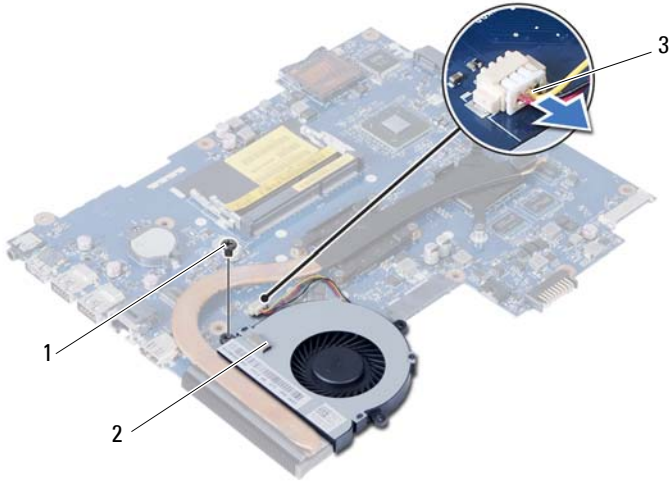

1 screw

2 fan

3 fan cable

Replacing the Fan



WARNING: Before working inside your computer, read the safety information that shipped with your computer and follow the steps in "Before You Begin" on page 7. After working inside your computer, follow the instructions in "After Working Inside Your Computer" on page 9. For additional safety best practices information, see the Regulatory Compliance Homepage at dell.com/regulatory_compliance.

Procedure

- 1 Align the screw holes on the fan with the screw holes on the system board.
- 2 Replace the screw that secures the fan to the system board.
- 3 Connect the fan cable to the connector on the system-board.

Postrequisites

- 1 Replace the system board. See "Replacing the System Board" on page 49.
- 2 Replace the wireless mini-card. See "Replacing the Wireless Mini-Card" on page 39.
- 3 Replace the palm-rest. See "Replacing the Palm-Rest" on page 35.
- 4 Replace the keyboard. See "Replacing the Keyboard" on page 29.
- 5 Replace the optical-drive assembly. See "Replacing the Optical-Drive Assembly" on page 21.
- 6 Replace the hard-drive assembly. See "Replacing the Hard-Drive Assembly" on page 25.
- 7 Follow the instructions from step 3 and step 4 in "Replacing the Memory Module(s)" on page 17.
- 8 Replace the battery. See "Replacing the Battery" on page 13.
- 9 Follow the instructions in "After Working Inside Your Computer" on page 9.

Removing the Speakers



WARNING: Before working inside your computer, read the safety information that shipped with your computer and follow the steps in "Before You Begin" on page 7. After working inside your computer, follow the instructions in "After Working Inside Your Computer" on page 9. For additional safety best practices information, see the Regulatory Compliance Homepage at dell.com/regulatory_compliance.

Prerequisites

- 1 Remove the battery. See "Removing the Battery" on page 11.
- 2 Follow the instructions from step 1 to step 2 in "Removing the Memory Module(s)" on page 15.
- 3 Remove the hard-drive assembly. See "Removing the Hard-Drive Assembly" on page 23.
- 4 Remove the optical-drive assembly. See "Removing the Optical-Drive Assembly" on page 19.
- 5 Remove the keyboard. See "Removing the Keyboard" on page 27.
- 6 Remove the palm-rest. See "Removing the Palm-Rest" on page 31.
- 7 Remove the wireless mini-card. See "Removing the Wireless Mini-Card" on page 37.
- 8 Remove the system board. See "Removing the System Board" on page 45.

Procedure

- 1 Peel the tape that secures the LED silicon tubes to the computer base.
- 2 Lift and remove the LED silicon tubes off the computer base.

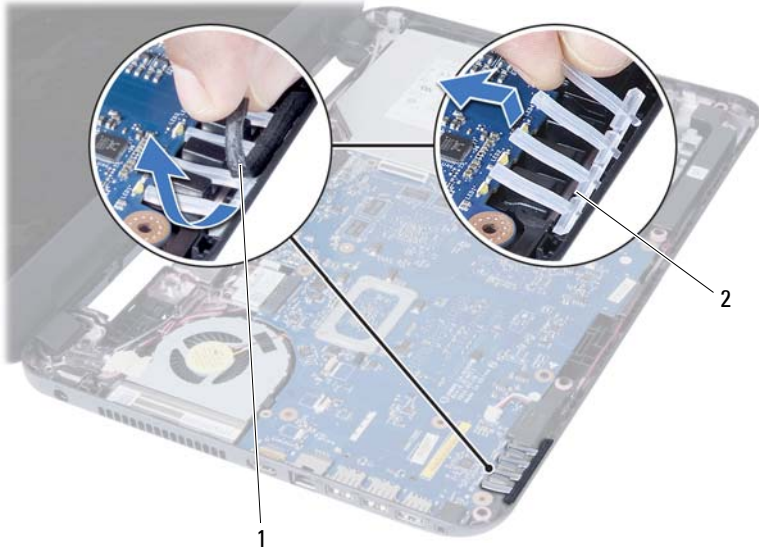

1 tape

2 LED silicon tubes

- 3 Note the speaker cable routing and remove the cable from the routing guides on the computer base.
- 4 Lift the speakers, along with the speaker cable, off the computer base.

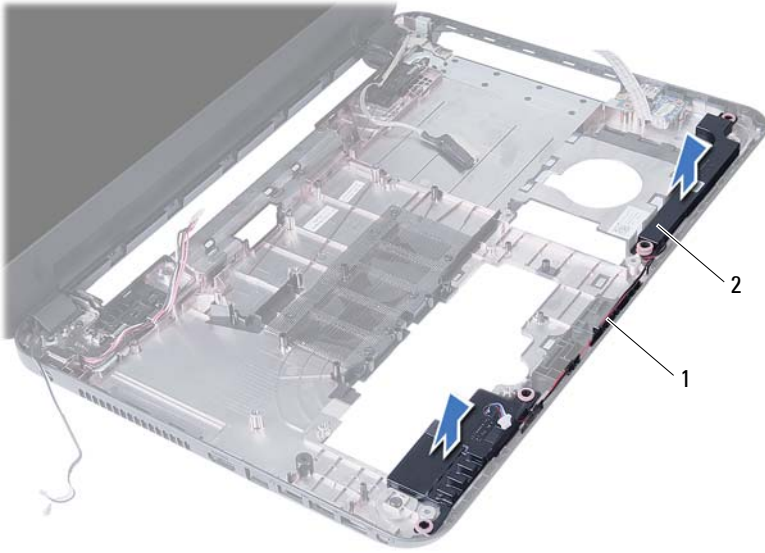

1 speaker cable routing

2 speakers (2)

Replacing the Speakers



WARNING: Before working inside your computer, read the safety information that shipped with your computer and follow the steps in "Before You Begin" on page 7. After working inside your computer, follow the instructions in "After Working Inside Your Computer" on page 9. For additional safety best practices information, see the Regulatory Compliance Homepage at dell.com/regulatory_compliance.

Procedure

- 1 Align the speakers on the computer base.
- 2 Route the speakers cable through the routing guides on the computer base.
- 3 Replace the LED silicon tubes to the computer base.
- 4 Adhere the tape that secures the LED silicon tubes to the computer base.

Postrequisites

- 1 Replace the system board. See "Replacing the System Board" on page 49.
- 2 Replace the wireless mini-card. See "Replacing the Wireless Mini-Card" on page 39.
- 3 Replace the palm-rest. See "Replacing the Palm-Rest" on page 35.
- 4 Replace the keyboard. See "Replacing the Keyboard" on page 29.
- 5 Replace the optical-drive assembly. See "Replacing the Optical-Drive Assembly" on page 21.
- 6 Replace the hard-drive assembly. See "Replacing the Hard-Drive Assembly" on page 25.
- 7 Follow the instructions from step 3 and step 4 in "Replacing the Memory Module(s)" on page 17.
- 8 Replace the battery. See "Replacing the Battery" on page 13.
- 9 Follow the instructions in "After Working Inside Your Computer" on page 9.

Removing the Display Assembly



WARNING: Before working inside your computer, read the safety information that shipped with your computer and follow the steps in "Before You Begin" on page 7. After working inside your computer, follow the instructions in "After Working Inside Your Computer" on page 9. For additional safety best practices information, see the Regulatory Compliance Homepage at dell.com/regulatory_compliance.

Prerequisites

- 1 Remove the battery. See "Removing the Battery" on page 11.
- 2 Follow the instructions from step 1 to step 2 in "Removing the Memory Module(s)" on page 15.
- 3 Remove the hard-drive assembly. See "Removing the Hard-Drive Assembly" on page 23.
- 4 Remove the optical-drive assembly. See "Removing the Optical-Drive Assembly" on page 19.
- 5 Remove the keyboard. See "Removing the Keyboard" on page 27.
- 6 Remove the palm-rest. See "Removing the Palm-Rest" on page 31.

Procedure

- 1 Peel the tape that secures the display cable to the system board.
- 2 Disconnect the display cable from the connectors on the system board.
- 3 Disconnect the wireless mini-card cables from the connectors on the wireless mini-card.

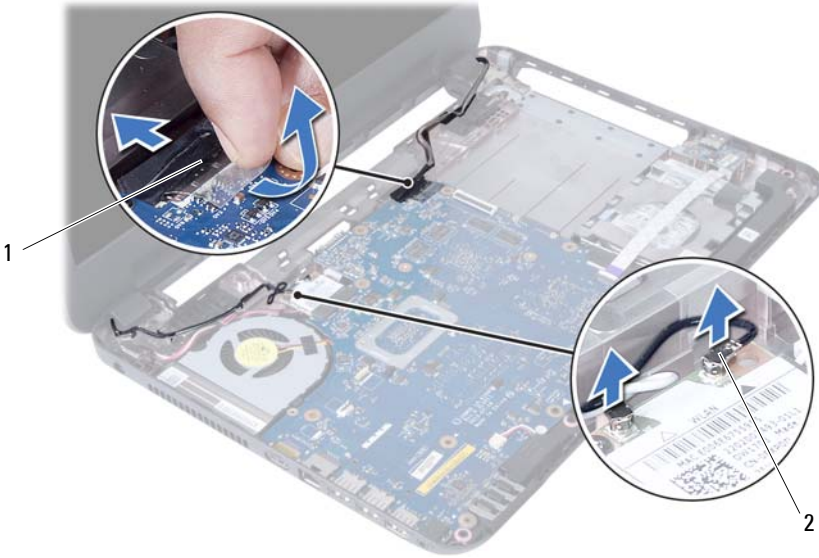

1 display cable

2 wireless mini-card cables (2)

- 4 Move aside the power adapter-port cable from the screws.
- 5 Remove the screws that secure the display assembly to the computer base.
- 6 Lift the display assembly off the computer base.



| | | | |
|---|--------------------------|---|------------|
| 1 | display assembly | 2 | screws (3) |
| 3 | power adapter-port cable | | |

Replacing the Display Assembly



WARNING: Before working inside your computer, read the safety information that shipped with your computer and follow the steps in "Before You Begin" on page 7. After working inside your computer, follow the instructions in "After Working Inside Your Computer" on page 9. For additional safety best practices information, see the Regulatory Compliance Homepage at dell.com/regulatory_compliance.

Procedure

- 1 Place the display assembly on the computer base and align the screw holes on the display assembly with the screw holes on the computer base.
- 2 Replace the screws that secure the display assembly to the computer base.
- 3 Connect the wireless mini-card cables to the connectors on the wireless mini-card.
- 4 Connect the display cable to the connector on the system board.
- 5 Adhere the tape that secures the display cable to the system board.

Postrequisites

- 1 Replace the palm-rest. See "Replacing the Palm-Rest" on page 35.
- 2 Replace the keyboard. See "Replacing the Keyboard" on page 29.
- 3 Replace the optical-drive assembly.
See "Replacing the Optical-Drive Assembly" on page 21.
- 4 Replace the hard-drive assembly. See "Replacing the Hard-Drive Assembly" on page 25.
- 5 Follow the instructions from step 3 and step 4 in "Replacing the Memory Module(s)" on page 17.
- 6 Replace the battery. See "Replacing the Battery" on page 13.
- 7 Follow the instructions in "After Working Inside Your Computer" on page 9.

Removing the Display Bezel



WARNING: Before working inside your computer, read the safety information that shipped with your computer and follow the steps in "Before You Begin" on page 7. After working inside your computer, follow the instructions in "After Working Inside Your Computer" on page 9. For additional safety best practices information, see the Regulatory Compliance Homepage at dell.com/regulatory_compliance.

Prerequisites

- 1 Remove the battery. See "Removing the Battery" on page 11.
- 2 Follow the instructions from step 1 to step 2 in "Removing the Memory Module(s)" on page 15.
- 3 Remove the hard-drive assembly. See "Removing the Hard-Drive Assembly" on page 23.
- 4 Remove the optical-drive assembly. See "Removing the Optical-Drive Assembly" on page 19.
- 5 Remove the keyboard. See "Removing the Keyboard" on page 27.
- 6 Remove the palm-rest. See "Removing the Palm-Rest" on page 31.
- 7 Remove the display assembly. See "Removing the Display Assembly" on page 69.

Procedure

- 1 Press the hinge covers on the sides and lift the hinge covers to remove it from the display assembly.



1 hinge covers (2)

- 2 Using your fingertips, carefully pry up the inside edge of the display bezel.
- 3 Remove the display bezel off the display back-cover.



1 display bezel

Replacing the Display Bezel



WARNING: Before working inside your computer, read the safety information that shipped with your computer and follow the steps in "Before You Begin" on page 7. After working inside your computer, follow the instructions in "After Working Inside Your Computer" on page 9. For additional safety best practices information, see the Regulatory Compliance Homepage at dell.com/regulatory_compliance.

Procedure

- 1 Align the display bezel with the display back-cover, and gently snap the display bezel into place.
- 2 Align the hinge covers with the hinges on the display assembly and snap the hinge covers into place.

Postrequisites

- 1 Replace the display assembly. See "Replacing the Display Assembly" on page 73.
- 2 Replace the palm-rest. See "Replacing the Palm-Rest" on page 35.
- 3 Replace the keyboard. See "Replacing the Keyboard" on page 29.
- 4 Replace the optical-drive assembly. See "Replacing the Optical-Drive Assembly" on page 21.
- 5 Replace the hard-drive assembly. See "Replacing the Hard-Drive Assembly" on page 25.
- 6 Follow the instructions from step 3 and step 4 in "Replacing the Memory Module(s)" on page 17.
- 7 Replace the battery. See "Replacing the Battery" on page 13.
- 8 Follow the instructions in "After Working Inside Your Computer" on page 9.

Removing the Display Hinges



WARNING: Before working inside your computer, read the safety information that shipped with your computer and follow the steps in "Before You Begin" on page 7. After working inside your computer, follow the instructions in "After Working Inside Your Computer" on page 9. For additional safety best practices information, see the Regulatory Compliance Homepage at dell.com/regulatory_compliance.

Prerequisites

- 1 Remove the battery. See "Removing the Battery" on page 11.
- 2 Follow the instructions from step 1 to step 2 in "Removing the Memory Module(s)" on page 15.
- 3 Remove the hard-drive assembly. See "Removing the Hard-Drive Assembly" on page 23.
- 4 Remove the optical-drive assembly. See "Removing the Optical-Drive Assembly" on page 19.
- 5 Remove the keyboard. See "Removing the Keyboard" on page 27.
- 6 Remove the palm-rest. See "Removing the Palm-Rest" on page 31.
- 7 Remove the display assembly. See "Removing the Display Assembly" on page 69.
- 8 Remove the display bezel. See "Removing the Display Bezel" on page 75.

Procedure

- 1 Remove the screws that secure the display hinges to the display panel.
- 2 Lift the display hinges off the display back-cover.



1 screws (8)

2 display hinges (2)

Replacing the Display Hinges



WARNING: Before working inside your computer, read the safety information that shipped with your computer and follow the steps in "Before You Begin" on page 7. After working inside your computer, follow the instructions in "After Working Inside Your Computer" on page 9. For additional safety best practices information, see the Regulatory Compliance Homepage at dell.com/regulatory_compliance.

Procedure

- 1 Align the screw holes on the display hinges with the screw holes on the display back-cover.
- 2 Replace the screws that secure the display hinges to the display back-cover.

Postrequisites

- 1 Replace the display bezel. See "Replacing the Display Bezel" on page 77.
- 2 Replace the display assembly. See "Replacing the Display Assembly" on page 73.
- 3 Replace the palm-rest. See "Replacing the Palm-Rest" on page 35.
- 4 Replace the keyboard. See "Replacing the Keyboard" on page 29.
- 5 Replace the optical-drive assembly. See "Replacing the Optical-Drive Assembly" on page 21.
- 6 Replace the hard-drive assembly. See "Replacing the Hard-Drive Assembly" on page 25.
- 7 Follow the instructions from step 3 and step 4 in "Replacing the Memory Module(s)" on page 17.
- 8 Replace the battery. See "Replacing the Battery" on page 13.
- 9 Follow the instructions in "After Working Inside Your Computer" on page 9.

Removing the Display Panel



WARNING: Before working inside your computer, read the safety information that shipped with your computer and follow the steps in "Before You Begin" on page 7. After working inside your computer, follow the instructions in "After Working Inside Your Computer" on page 9. For additional safety best practices information, see the Regulatory Compliance Homepage at dell.com/regulatory_compliance.

Prerequisites

- 1 Remove the battery. See "Removing the Battery" on page 11.
- 2 Follow the instructions from step 1 to step 2 in "Removing the Memory Module(s)" on page 15.
- 3 Remove the hard-drive assembly. See "Removing the Hard-Drive Assembly" on page 23.
- 4 Remove the optical-drive assembly. See "Removing the Optical-Drive Assembly" on page 19.
- 5 Remove the keyboard. See "Removing the Keyboard" on page 27.
- 6 Remove the palm-rest. See "Removing the Palm-Rest" on page 31.
- 7 Remove the display assembly. See "Removing the Display Assembly" on page 69.
- 8 Remove the display bezel. See "Removing the Display Bezel" on page 75.
- 9 Remove the display hinges. See "Removing the Display Hinges" on page 79.

Procedure

- 1 Remove the screws that secure the display panel to the display back-cover.
- 2 Gently lift the display panel and turn it over.

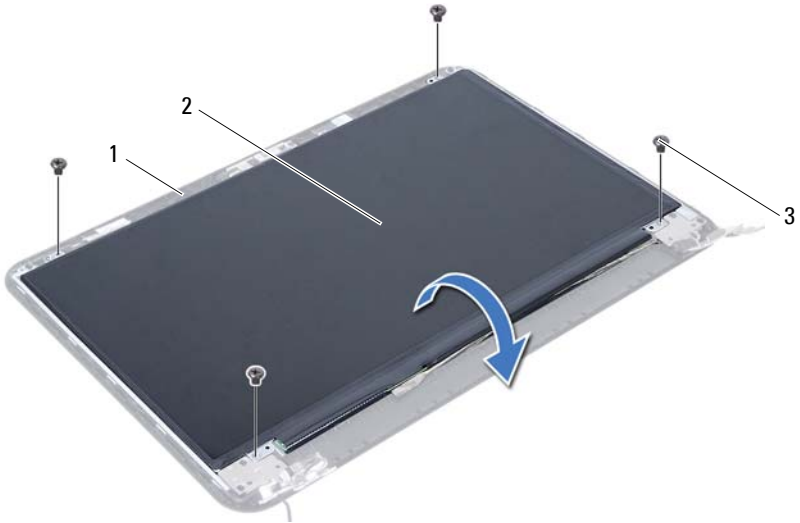

| | |
|---|--------------------|
| 1 | display back-cover |
| 3 | screws (4) |

| | |
|---|---------------|
| 2 | display panel |
|---|---------------|

- 3 Peel the tape that is adhered over the display cable.
- 4 Disconnect the display cable from the connector on the display panel.

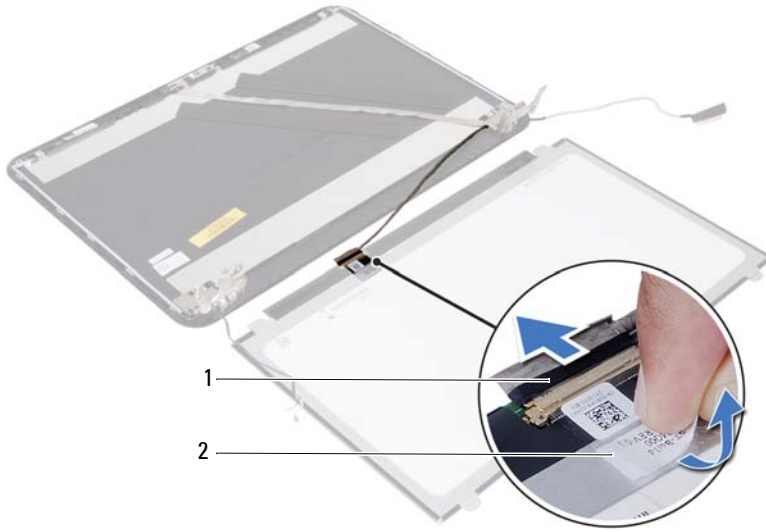

1 display cable

2 tape

Replacing the Display Panel



WARNING: Before working inside your computer, read the safety information that shipped with your computer and follow the steps in "Before You Begin" on page 7. After working inside your computer, follow the instructions in "After Working Inside Your Computer" on page 9. For additional safety best practices information, see the Regulatory Compliance Homepage at dell.com/regulatory_compliance.

Procedure

- 1 Connect the display cable to the connector on the display panel.
- 2 Adhere the tape that secures the display cable.
- 3 Gently place the display panel on the display back cover.
- 4 Align the screw holes on the display panel with the screw holes on the display back-cover.
- 5 Replace the screws that secure the display panel to the display back-cover.

Postrequisites

- 1 Replace the display hinges. See "Replacing the Display Hinges" on page 81.
- 2 Replace the display bezel. See "Replacing the Display Bezel" on page 77.
- 3 Replace the display assembly. See "Replacing the Display Assembly" on page 73.
- 4 Replace the palm-rest. See "Replacing the Palm-Rest" on page 35.
- 5 Replace the keyboard. See "Replacing the Keyboard" on page 29.
- 6 Replace the optical-drive assembly. See "Replacing the Optical-Drive Assembly" on page 21.
- 7 Replace the hard-drive assembly. See "Replacing the Hard-Drive Assembly" on page 25.
- 8 Follow the instructions from step 3 and step 4 in "Replacing the Memory Module(s)" on page 17.
- 9 Replace the battery. See "Replacing the Battery" on page 13.
- 10 Follow the instructions in "After Working Inside Your Computer" on page 9.

Removing the Camera Module



WARNING: Before working inside your computer, read the safety information that shipped with your computer and follow the steps in "Before You Begin" on page 7. After working inside your computer, follow the instructions in "After Working Inside Your Computer" on page 9. For additional safety best practices information, see the Regulatory Compliance Homepage at dell.com/regulatory_compliance.

Prerequisites

- 1 Remove the battery. See "Removing the Battery" on page 11.
- 2 Follow the instructions from step 1 to step 2 in "Removing the Memory Module(s)" on page 15.
- 3 Remove the hard-drive assembly. See "Removing the Hard-Drive Assembly" on page 23.
- 4 Remove the optical-drive assembly. See "Removing the Optical-Drive Assembly" on page 19.
- 5 Remove the keyboard. See "Removing the Keyboard" on page 27.
- 6 Remove the palm-rest. See "Removing the Palm-Rest" on page 31.
- 7 Remove the display assembly. See "Removing the Display Assembly" on page 69.
- 8 Remove the display bezel. See "Removing the Display Bezel" on page 75.

Procedure

- 1 Remove the screw that secures the camera module to the display back-cover.
- 2 Disconnect the camera cable from the connector on the camera module.
- 3 Peel the tape that secures the camera module to the display back-cover.
- 4 Lift the camera module off the display back-cover.

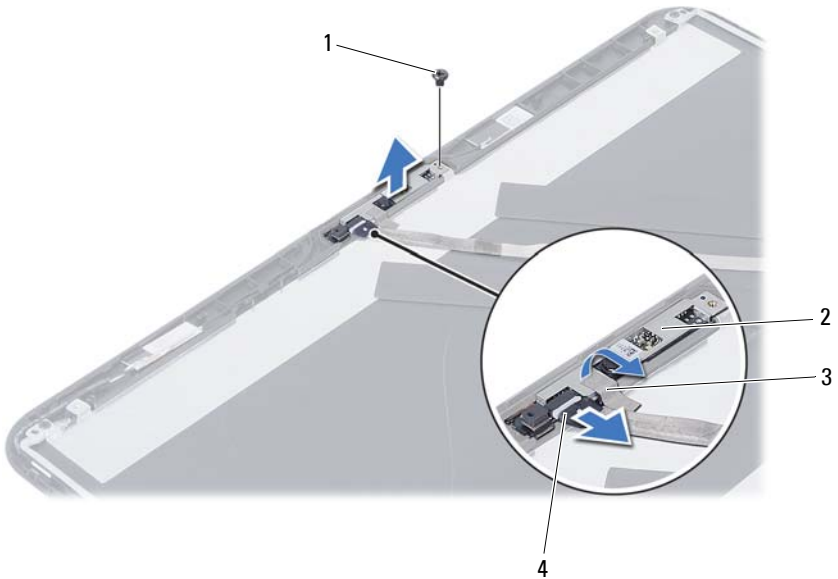

1 screw

2 camera module

3 tape

4 camera cable

Replacing the Camera Module



WARNING: Before working inside your computer, read the safety information that shipped with your computer and follow the steps in "Before You Begin" on page 7. After working inside your computer, follow the instructions in "After Working Inside Your Computer" on page 9. For additional safety best practices information, see the Regulatory Compliance Homepage at dell.com/regulatory_compliance.

Procedure

- 1 Align the camera module on the display back-cover.
- 2 Replace the screw that secures the camera module to the display back-cover.
- 3 Adhere the tape that secures the camera module to the display back-cover.
- 4 Connect the camera cable to the connector on the camera module.

Postrequisites

- 1 Replace the display bezel. See "Replacing the Display Bezel" on page 77.
- 2 Replace the display assembly. See "Replacing the Display Assembly" on page 73.
- 3 Replace the palm-rest. See "Replacing the Palm-Rest" on page 35.
- 4 Replace the keyboard. See "Replacing the Keyboard" on page 29.
- 5 Replace the optical-drive assembly. See "Replacing the Optical-Drive Assembly" on page 21.
- 6 Replace the hard-drive assembly. See "Replacing the Hard-Drive Assembly" on page 25.
- 7 Follow the instructions from step 3 and step 4 in "Replacing the Memory Module(s)" on page 17.
- 8 Replace the battery. See "Replacing the Battery" on page 13.
- 9 Follow the instructions in "After Working Inside Your Computer" on page 9.

Flashing the BIOS

You may need to flash the BIOS when an update is available or after replacing the system board. To flash the BIOS:

- 1 Turn on the computer.
- 2 Go to **support.dell.com/support/downloads**.
- 3 Locate the BIOS update file for your computer:



NOTE: The Service Tag for your computer is located on a label at the back of your computer. For more information, see the *Quick Start Guide* that shipped with your computer.

If you have your computer's Service Tag or Express Service Code:

- a Enter your computer's Service Tag or Express Service Code in the **Service Tag or Express Service Code** field.
- b Click **Submit** and proceed to step 4.

If you do not have your computer's Service Tag or Express Service Code:

- a Select one of the following options:
 - **Automatically detect my Service Tag for me**
 - **Choose from My Products and Services List**
 - **Choose from a list of all Dell products**
- b Click **Continue** and follow the instructions on the screen.
- 4 A list of results appears on the screen. Click **BIOS**.
- 5 Click **Download File** to download the latest BIOS file.
- 6 In the **Please select your download method below** window, click **For Single File Download via Browser**, and then click **Download Now**. The **File Download** window appears.
- 7 In the **Save As** window, select an appropriate location to download the file on your computer.
- 8 If the **Download Complete** window appears, click **Close**.
- 9 Navigate to the folder where you downloaded the BIOS update file.
- 10 Double-click the BIOS update file icon and follow the instructions that appear on the screen.

